



INSTRUCTION MANUAL

TLS-9024P

Time Lapse Video Cassette Recorder

English

Time Lapse Videorecorder

Deutsch

Magnétoscope time lapse à cassette

Français

Videograbador en lapsos de tiempo

Español

Videoregistratore a casette, a fotogrammi differenziati

Italiano

时延录像机

中国简体



Please read this manual carefully before connecting your VCR and operating it for the first time.
Be sure to read carefully and follow all the PRECAUTIONS on page 1.
Keep the manual in a safe place for future reference.

PRECAUTIONS

WARNING: TO REDUCE THE RISK OF FIRE OR ELECTRIC SHOCK, DO NOT EXPOSE THIS APPLIANCE TO RAIN OR OTHER MOISTURE. To avoid electrical shock, do not open the cabinet. Refer servicing to qualified personnel only. If the power supply cord (AC power cord) of this appliance is damaged, it must be replaced. Return to a SANYO Authorised Service Centre for replacement of the cord.

CAUTION: Do not put your hand or other objects in the cassette loading slot because of risk of injury or accident. Be sure to keep small children away from the VCR.

Location

For safe operation and satisfactory performance of your VCR, keep the following in mind when selecting a place for its installation:

- Shield it from direct sunlight and keep it away from sources of intense heat.
- Avoid dusty or humid places.
- Avoid places with insufficient ventilation for proper heat dissipation. Do not block the ventilation holes of the VCR. Do not place the unit on a carpet because this will block the ventilation holes.
- Install the VCR in a horizontal position only.
- Avoid locations subject to strong vibrations.
- Avoid moving the VCR between cold and hot locations (see "Moisture Condensation Problems", this page).
- Do not place the VCR directly on top of the TV, as this may cause playback or recording problems.

Avoiding Electrical Shock and Fire

- Do not handle the power cord with wet hands.
- Do not pull on the power cord when disconnecting it from an AC wall outlet. Grasp it by the plug.
- If any liquid is spilled on the VCR, unplug the power cord immediately and have the unit inspected at a factory-authorized service centre.
- Do not place anything directly on top of this VCR.

Moisture Condensation Problems

Cause:

When the VCR is first installed, moved from a cold area to a warm area or placed in a location with high humidity, dew (moisture) may form in the unit. The Dew indicator (d d d d) blinks. If you operate the VCR with dew inside, damage may result.

Prevention:

- ❶ Make all necessary connections.
- ❷ Plug the power cord into a 220 – 240 V AC outlet.
- ❸ Do not operate the VCR for approximately 2 hours.

When the VCR reaches room temperature, the Dew indicator (d d d d) will turn off and the VCR will be ready to operate.

Power on/stand-by mode

The power on/stand-by mode is selected by pressing the **STANDBY/ON** button.

VCR display

Stand-by mode

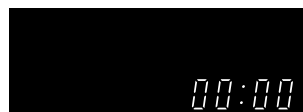

Power on mode



"Stand-by mode" is the condition in which only the time is displayed.

Do not forget that even in the stand-by mode there is an electrical voltage inside the VCR as long as it is connected to a wall socket.

Disconnect the power cord from the wall socket if the VCR is not to be used for a long time.

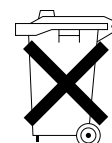

Bij dit produkt zijn batterijen geleverd. Wanneer deze leeg zijn, moet u ze niet weggooien maar inleveren als KCA.



FEATURES

- JOG/SHUTTLE operation
- Can also be controlled through an RS-232C or RS-485 connection
- Clog detection
- High-speed Fast Forward/Rewind
- Field recording/playback
- 3, 12 and 24-hour mode recording
- In 3, 12, 24-hour modes audio recording is available
- Autorepeat recording
- Alarm recording function
- On-screen mode setting
- Integrated time date generator
- Day/Time search function
- Alarm scan/search function
- Forward/Reverse frame advance function
- 30-day memory backup
- Security lock
- Recording check function
- Automatic head cleaning function

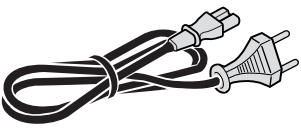
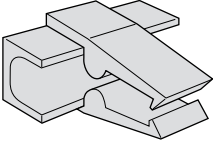
ACCESSORIES

Power cord	Holder
	
----- or -----	
 <p data-bbox="216 1630 326 1664" style="text-align: center;">U.K. only</p>	

CONTENTS

PRECAUTIONS	1
FEATURES	2
ACCESSORIES	2
LOCATIONS OF CONTROLS AND INDICATORS	3
CONNECTIONS	6
TYPES OF ON-SCREEN DISPLAYS AND DISPLAY SEQUENCE	8
SETTING THE LANGUAGE AND CLOCK	10
CHANGING THE ON-SCREEN DISPLAY	11
VIDEO CASSETTE TAPES	12
NORMAL RECORDING	14
AUTOREPEAT RECORDING	17
ALARM RECORDING	18
PROGRAMME TIMER RECORDING	21
RECORDING USING AN EXTERNAL TIMER INPUT	24
NORMAL PLAYBACK	25
SPECIAL PLAYBACK	26
TAPE COUNTER	28
SETTING THE SECURITY LOCK	28
SETTING THE BUZZER	29
SETTING THE RS-232C OR RS-485 DATA TRANSFER SPEED	30
CHECKING POWER FAILURE, FAILURE DUE TO CONDENSATION AND USAGE DURATION	31
OUTPUT TERMINALS	32
MAINTENANCE	34
TROUBLESHOOTING GUIDE	36
SPECIFICATIONS	37

LOCATIONS OF CONTROLS AND INDICATORS

Front Panel

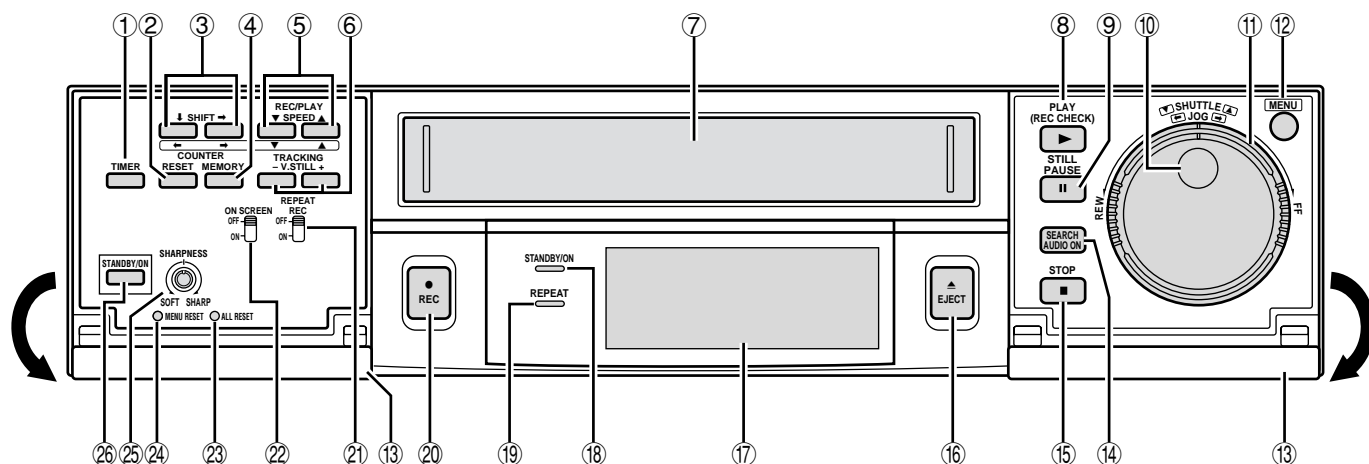

- | | |
|--|--|
| ① TIMER button | ①⑦ Digital display panel |
| ② COUNTER RESET button | ①⑧ STANDBY/ON indicator |
| ③ SHIFT ↓ or → (display position down or right) button | ①⑨ REPEAT (autorepeat recording) indicator |
| ④ COUNTER MEMORY button | ①⑩ REC (record) button |
| ⑤ REC/PLAY SPEED ▼ or ▲ (decrease or increase recording/playback speed mode) button | ①⑪ REPEAT REC (autorepeat recording) switch |
| ⑥ TRACKING/V. STILL – or + button | ①⑫ ON SCREEN switch |
| ⑦ Cassette loading slot | ①⑬ ALL RESET button |
| ⑧ PLAY (REC CHECK) button | ①⑭ MENU RESET button |
| ⑨ STILL/PAUSE button | ①⑮ SHARPNESS control |
| ⑩ JOG dial | ①⑯ STANDBY/ON button |
| ⑪ SHUTTLE ring | |
| ⑫ MENU button | |
| ⑬ Front door | |
| ⑭ SEARCH/AUDIO ON button | |
| ⑮ STOP button | |
| ⑯ EJECT button | |

NOTE:

- Buttons ③ and ⑤ are also used for menu control.

LOCATIONS OF CONTROLS AND INDICATORS

Digital Display

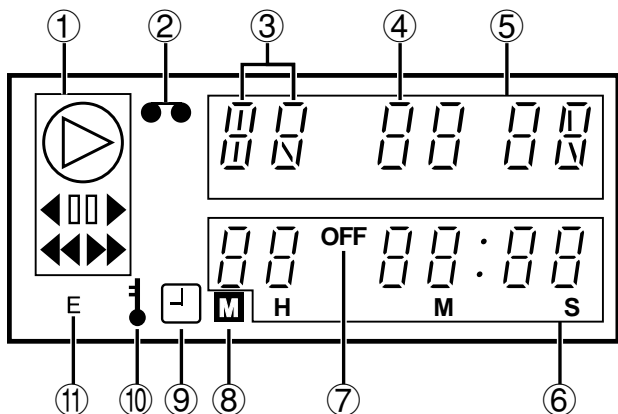

① Operation Indicators

- They display the actual operation mode.

Operation Mode	Indicator
Record (REC)	○
Record pause (REC PAUSE)	○ + [RECORD PAUSE]
Playback (PLAY)	▷
Still image (STILL)	▷ + [RECORD PAUSE]
Fast forward (FF)	▶▶
Rewind (REW)	◀◀
Forward picture search	▷ + ▶▶
Reverse picture search	▷ + ◀◀
Reverse playback	▷ + [REVERSE]
Field shift forward	▷ + [FIELD]
Field shift backward	▷ + [FIELD]

- Clog detection indicator Flashes when the recording quality deteriorates due to dirty VCR heads.

- ② Cassette indicator Comes on when a cassette is loaded.

- ③ Alarm indicator Flashes when an alarm is being recorded:
Comes on after the alarm has been recorded:

- ④ Power failure indicator Comes on after a power failure.

- ⑤ Mode display
 - Recording/playback speed mode
 - Alarm search mode

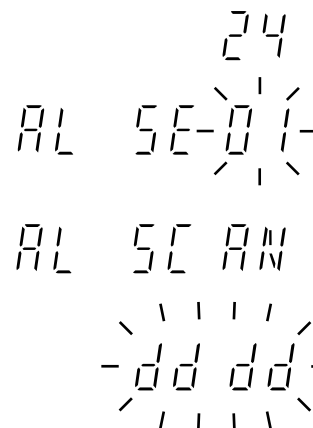

- Alarm scan mode
- Dew display

⑤, ⑥ Mode display

- Day/Time search mode

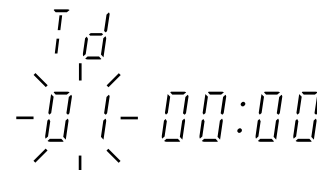

⑥ Counter display

- Time display

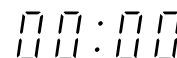

- Linear time counter display

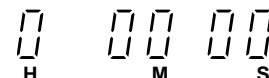

⑦ OFF indicator OFF

Comes on when the tape end has been reached after a recording, except during autorepeat recording mode.

⑧ Counter memory indicator

Comes on when the counter memory function is engaged.

⑨ Timer Recording indicator

Comes on when in timer recording stand-by mode, or during a timer recording.

⑩ Security lock indicator

Comes on when the security lock is engaged.

⑪ External input indicator E

Comes on when recording using the **EXT TIMER IN** input terminal.

LOCATIONS OF CONTROLS AND INDICATORS

Back Panel

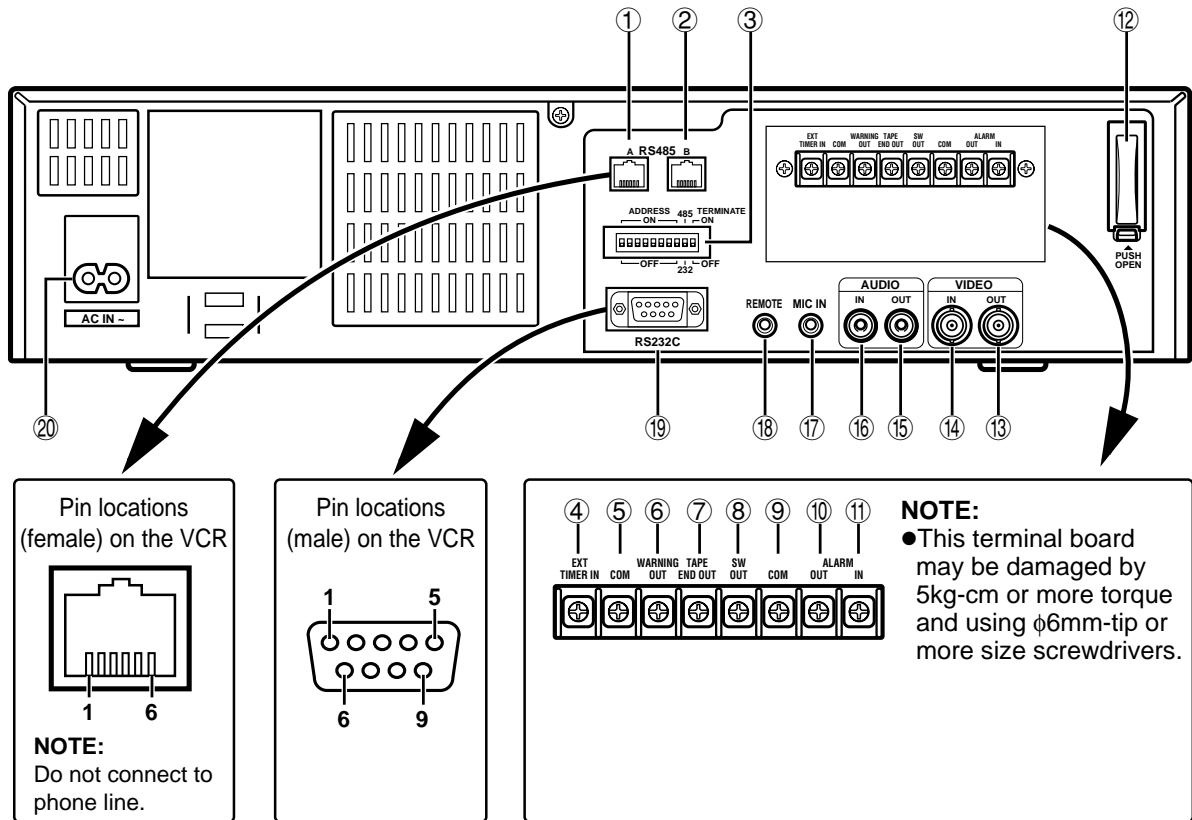

- ① RS485 A connector (RJ11 type)
- ② RS485 B connector (RJ11 type)
- ③ DIP switches
 - Used when controlling the VCR through the RS485 or the RS232C connectors.
- ④ EXT TIMER IN (external timer input) terminal
- ⑤ COM (common) terminal
- ⑥ WARNING OUT (warning output) terminal
- ⑦ TAPE END OUT (tape end output) terminal
- ⑧ SW OUT (switch output) terminal
- ⑨ COM (common) terminal
- ⑩ ALARM OUT (alarm output) terminal
- ⑪ ALARM IN (alarm input) terminal
- ⑫ Battery compartment
- ⑬ VIDEO OUT (video output) jack
- ⑭ VIDEO IN (video input) jack
- ⑮ AUDIO OUT (audio output) jack
- ⑯ AUDIO IN (audio input) jack
- ⑰ MIC IN (microphone input) jack
- ⑱ RS232C connector (D-sub 9-pin type)
- ⑳ AC power input

CONNECTIONS

Connect the video camera and monitor TV as shown in the figure below.

NOTE: Before making the connections, make sure the devices are disconnected from the power outlet.

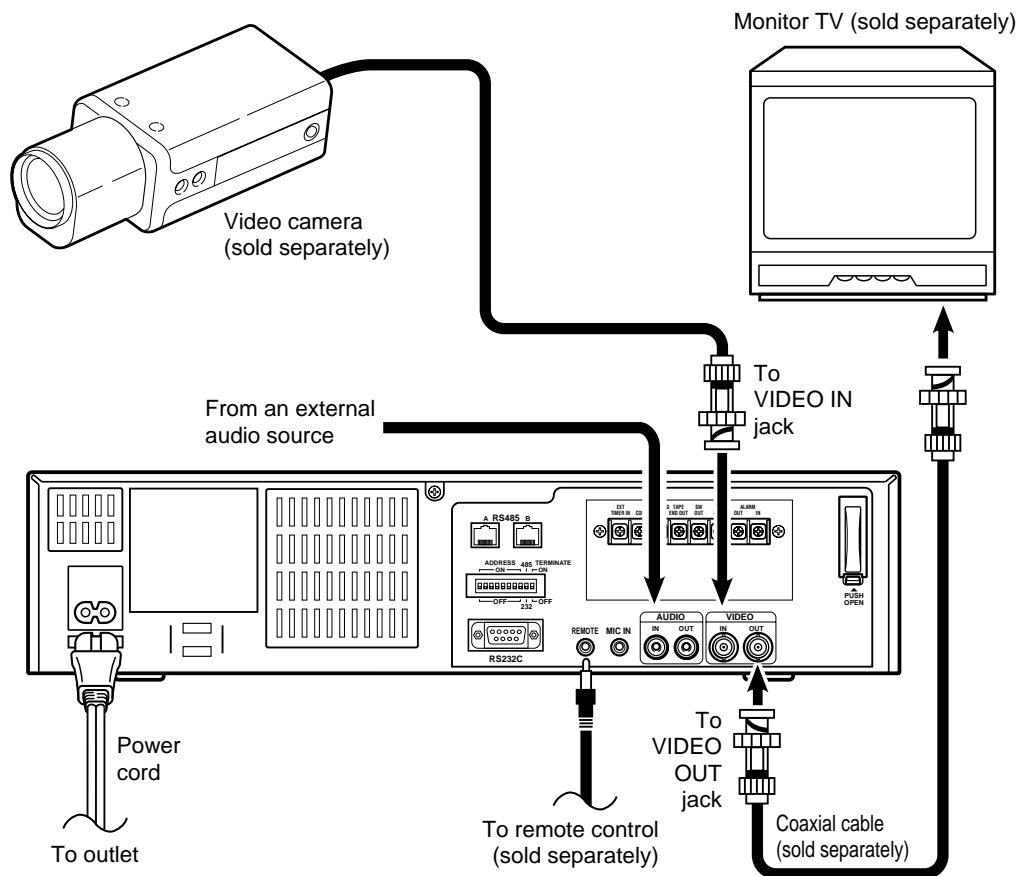

IMPORTANT NOTE (U. K. Only)

The wires in the mains lead are coloured according to the following code:

Blue: Neutral

Brown: Live

If the colours of the wires in the mains lead of this apparatus do not correspond with the colour markings identifying the terminals in your plug, proceed as follows:

- The wire which is coloured blue must be connected to the terminal which is marked with the letter **N** or coloured blue or black.
- The wire which is coloured brown must be connected to the terminal which is marked with the letter **L** or coloured brown or red.
- Do not connect either wire to the **Earth** terminal.

NOTES:

- For more details, please refer to the manuals accompanying all other devices. If the connections are not made properly, it may cause a fire or damage the equipment.
- You can use a VA-RMN01 Remote Control Unit (sold separately) to control remotely the VCR.
- If there is no video signal when the power is turned on, "NO VIDEO" will be displayed on-screen.

CONNECTIONS

Power cord

- 1 Plug the power cord (supplied) into the AC power input (AC IN ~) on the VCR back panel. Insert the plug straight and firmly.
- 2 Install the AC power cord into the holder.

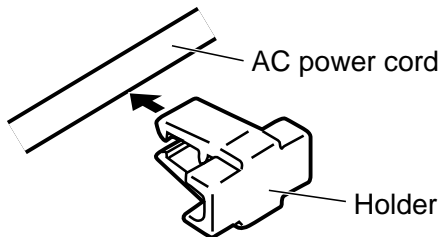

- 3 Fix the holder to the VCR back panel.

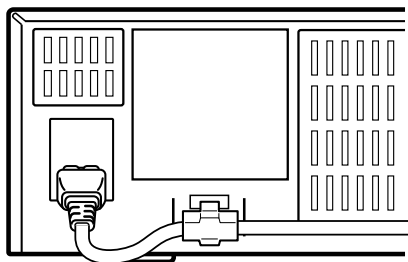
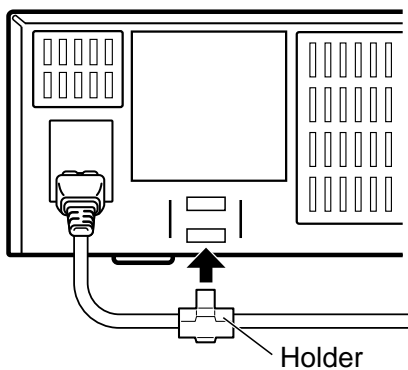

About the memory reset

If the VCR location is changed or to cancel previous settings, please reset the memory as described below. All the settings as the time and date will be reset, and the security lock will be cancelled.

To reset the memory, press the **ALL RESET** button.

TYPES OF ON-SCREEN DISPLAYS AND DISPLAY SEQUENCE

Reference pages are shown in square brackets.

Monitor TV screen (normal screen)

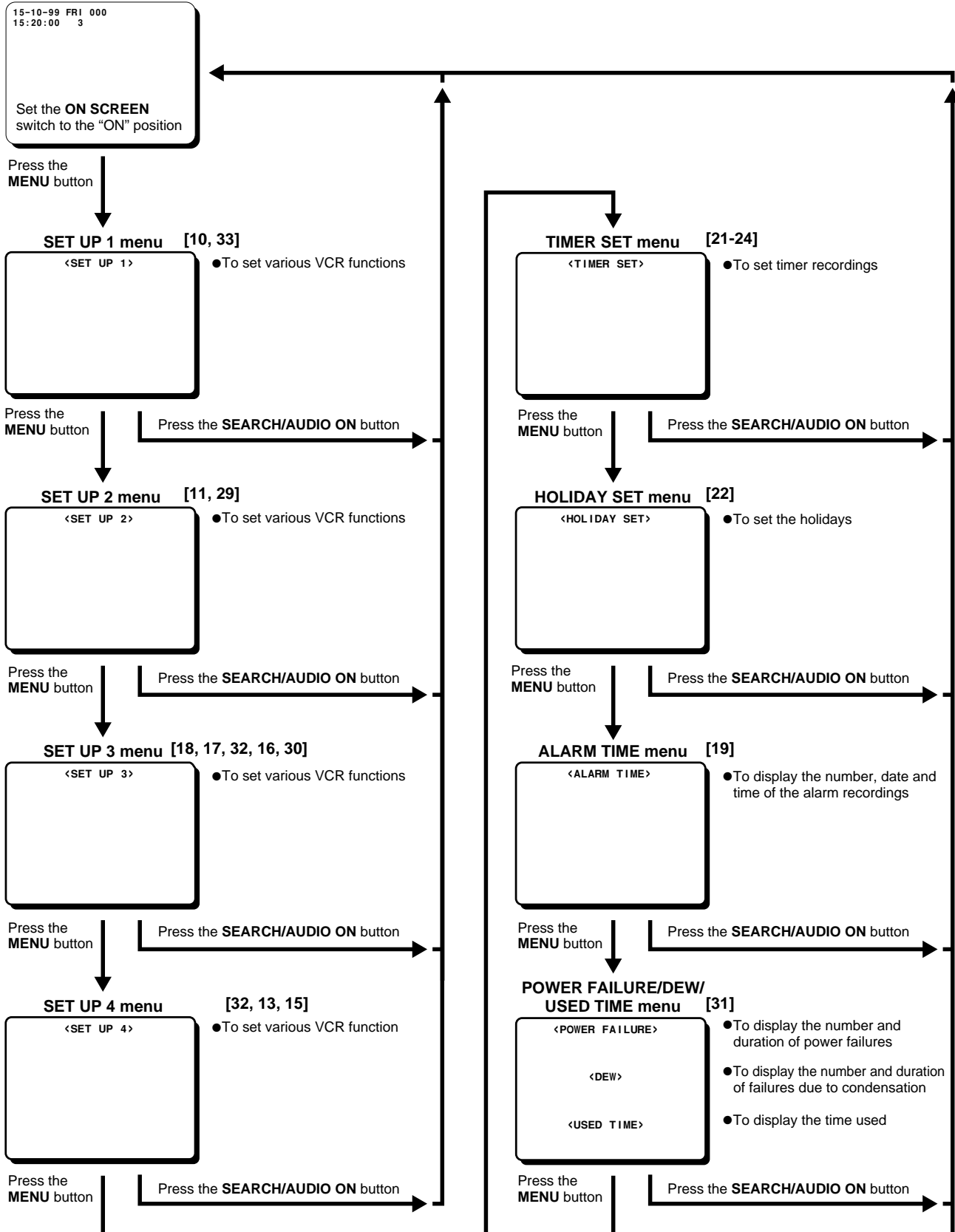

TYPES OF ON-SCREEN DISPLAYS AND DISPLAY SEQUENCE

NOTES:

- When a menu is displayed, recording will not be possible.
- Press the **SEARCH/AUDIO ON** or **MENU** button, the setting procedure is now completed.
- During recording or playback the menus cannot be displayed.
- To reset the settings of a menu to their original values, select the desired menu then press the **MENU RESET** button. The (USED TIME) menu data cannot be reset.
- To enter the settings use the **JOG** dial or **SHUTTLE** ring.

Using the JOG dial and SHUTTLE ring

JOG dial

- Put the tip of your index finger into the depression then turn the dial in any direction.
- When a menu is displayed, turn the dial clockwise and the cursor will move to the right (or down). Turn the dial counterclockwise and the cursor will move to the left (or up).

SHUTTLE ring

- When a menu is displayed, turn the ring of 10° or more clockwise and the selected data setting will change or the selected setting value will increase. Turn the ring of 10° or more counterclockwise and the selected data setting will change or the selected setting value will decrease.
- If held for 1 second or more the changes will be made sequentially.

SETTING THE LANGUAGE AND CLOCK

Language Setting

English, French or German can be selected by the user.

- 1 Turn the power on to all devices used.
- 2 Press the **MENU** button to display the (SET UP 1) menu.

```

<SET UP 1>
*SUMMER TIME SET NO USE
WEEK MONTH TIME
ON LST-SUN 03 02:00
OFF LST-SUN 10 02:00

*CLOCK SET
01-01-00 SAT 00:00:00
*REMOTE EJECT
*LANGUAGE-LANGUE-SPRACHE
ENGLISH
    
```

- 3 Turn the **JOG** dial, until "ENGLISH" is flashing.
- 4 Turn the **SHUTTLE** ring to select the language of your choice.
- 5 Press the **SEARCH/AUDIO ON** button to save the setting.

Clock setting

Example: To set the clock to October 15, 1999 at 3:20 PM (15:20).

- 1 Press the **MENU** button to display the (SET UP 1) menu.
- 2 Turn the **SHUTTLE** ring, to set the auto summer time/standard time adjustment.
 - NO USE No summer time/standard time adjustment is made.
 - USE The auto summer time/standard time adjustment is made.
- 3 Turn the **JOG** dial clockwise, until "LST" is flashing.
- 4 Set the day the summer time adjustment is made.
 - Turn the **SHUTTLE** ring to set the week, then turn the **JOG** dial clockwise.
1ST, 2ND, 3RD, 4TH or LST (first, second, third, fourth or last)
 - Turn the **SHUTTLE** ring to set the day of week, then turn the **JOG** dial clockwise.
SUN, MON, TUE, SAT (Sunday, Monday, Tuesday....Saturday)

- 5 Turn the **SHUTTLE** ring to set the month the summer time adjustment is made, then turn the **JOG** dial clockwise.
01, 02,.....11, 12 (for January, February.....November, December)
- 6 Turn the **SHUTTLE** ring to set the time the summer time adjustment is made.
- 7 Turn the **JOG** dial clockwise, until "LST" is flashing.
- 8 Following the same procedure as above (steps 4 to 6), set when the time is changed back from summer time to standard time.
- 9 Turn the **JOG** dial clockwise, until the "CLOCK SET" setting is flashing.
- 10 Turn the **SHUTTLE** ring to set the day (ex: 15), then turn the **JOG** dial clockwise.
 - o *The day of week is set automatically.*
- 11 Turn the **SHUTTLE** ring to set the month (ex: 10), then turn the **JOG** dial clockwise.
- 12 Turn the **SHUTTLE** ring to set the year (ex: 99 for 1999), then turn the **JOG** dial clockwise.
 - o *The last 2 digits only are displayed.*
- 13 Turn the **SHUTTLE** ring to set the hours (ex: 15 for 3 PM), then turn the **JOG** dial clockwise.
- 14 Turn the **SHUTTLE** ring to set the minutes (ex: 20), then turn the **JOG** dial clockwise.

```

<SET UP 1>
*SUMMER TIME SET USE
WEEK MONTH TIME
ON LST-SUN 03 02:00
OFF LST-SUN 10 02:00

*CLOCK SET
15-10-99 FRI 15:20:00
*REMOTE EJECT
*LANGUAGE-LANGUE-SPRACHE
ENGLISH
    
```

- 15 For accurate clock setting, turn the **SHUTTLE** ring counterclockwise timed with a time broadcast, or other accurate time signal, this will start the seconds counting from 00.
- 16 Press **SEARCH/AUDIO ON** button.
 - o *The setting procedure is now completed.*

NOTES:

- Clock display is only 24 hours.
- In STOP mode, press and hold the **STOP** button then press the **TRACKING/V.STILL-** button to reset the minutes and seconds to 00 (to the closest hour). For example, between 13:30:00 and 14:29:59 the clock is reset to 14:00:00.

CHANGING THE ON-SCREEN DISPLAY

Selecting the On-screen Display

You can select to display or not the date, time, the number of alarm recordings and tape speed.

- 1 Turn the power on to all devices used.
- 2 Press the **MENU** button until the (SET UP 2) menu is displayed.

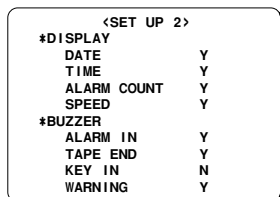

- 3 Turn the **JOG** dial clockwise, until the desired item for which the display function will be set is flashing.
- 4 Turn the **SHUTTLE** ring to set "Y" for the functions described below.

- DATE The date is displayed
- TIME The time is displayed
- ALARM COUNT . . . The number of alarm recordings is displayed
- SPEED The recording/playback speed mode is displayed

- 5 Press the **SEARCH/AUDIO ON** button to save the settings.

NOTE:

- If the **ON SCREEN** switch is set to the "ON" position, the items for which "Y" is set are recorded. The items for which "N" was set at step 4 above are not recorded.

Changing the Date/Time Display Position

- 1 Turn the power on to all input devices to the VCR.
- 2 Set the **ON SCREEN** switch to the "ON" position.
 - o *The date and time are displayed.*

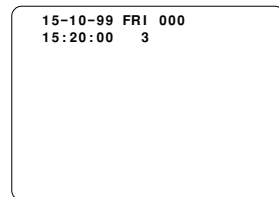

- 3 Press the **SHIFT** → (or ↓) button.
 - o *The display will move towards the right (or the bottom).*

NOTES:

- If the **SHIFT** → (or ↓) button is kept pressed for 1 second or more the display will move at a faster speed.
- The display position cannot be changed while recording.

VIDEO CASSETTE TAPES

Use only video cassette tapes bearing the **VHS** logo. This VCR was primarily designed for use with E-180 cassette tapes, it is recommended to use E-180 standard grade VHS video cassette tapes for optimal performance.

Handling Cassette Tapes

The cassette tapes should always be stored vertically, in their cases, away from high temperatures, magnetic fields, direct sunlight, dirt, dust and locations subject to mold formation.

Do not tamper with the cassette mechanism and never touch the tape with your fingers.

Protect the cassette tapes from shocks or strong vibrations.

To Protect your Recordings

After having recorded a tape, if you wish to keep the recording, use a flathead screwdriver to break off the erasure-prevention tab on the cassette.

To record again on a tape without erasure-prevention tab, cover the hole with adhesive tape.

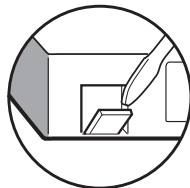
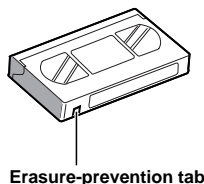

Precautions concerning the video cassette tapes

- Do not use tapes that are damaged, tapes that have been cut and repaired or tapes that have been altered in any way.
- Some rewinders may entangle the tape, and therefore their use is not recommended.
- When tapes are recorded over and over again, the recording quality will deteriorate. Refer to "Concerning the Number of Times Tapes can be Rerecorded on" on page 15, and replace the tape with a new tape as required.

Loading

- ① Place the cassette, label side up, in the loading slot. Gently push the centre of the cassette until it is loaded automatically.

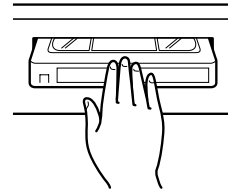

- The time display will switch to the reset counter "0:00:00" display.
- After the cassette tape is loaded, a mechanism will operate for about 5 seconds to check that the tape has been threaded correctly and the cassette indicator "●●" will blink during that period.
- When the cassette is loaded, if the tape has been threaded correctly, the cassette indicator "●●" will light on the digital display.

NOTE:

- If you try to record on a cassette without erasure-prevention tab, the VCR will eject the cassette.

Unloading

- ① In stop mode, press the **EJECT** button.
 - The cassette is automatically ejected.

NOTES:

- Do not insert any object in the cassette loading slot, as that may cause injury and damages to the VCR.
- If your hand gets stuck in the cassette loading slot, unplug the power cord and consult the dealer where the unit was bought. Do not forcibly pull the hand out as that may cause severe injuries.

VIDEO CASSETTE TAPES

Correct tape thread check function

If the correct tape thread check function is on, after the cassette tape is loaded, a mechanism will operate for about 5 seconds to check that the tape has been threaded (loaded) correctly and the cassette indicator “●●” will blink during that period. If the tape is not loaded properly, the cassette will be ejected.

NOTES:

- This function checks to make sure that the cassette has been correctly loaded. It is recommended to use this function to make sure the recordings are conducted reliably.
 - If during the tape thread check operation, the **REC**, **PLAY** or **STOP** button is pressed or if the **SHUTTLE** ring is turned, the command will only be executed after the tape thread has been checked. Only the **EJECT** button will operate while the tape thread is being checked.
- ① Press the **MENU** button until the (SET UP 4) menu is displayed.

<SET UP 4>	
*SW OUT	
FIELD	01
TIMING	FIELD
3H	Y
*THREAD CHECK	Y
*VIDEO LOSS	N
*REC SPEED	N

- ② Turn the **JOG** dial, until the “THREAD CHECK” setting is flashing.
- ③ Turn the **SHUTTLE** ring, to set the desired mode.
- Y The correct tape thread check function is on
- N The correct tape thread check function is off
- ④ Press the **SEARCH/AUDIO ON** button to save the setting.

NORMAL RECORDING

Normal Recording

Before starting

- Turn the power on to all devices used.
- Load a cassette tape with erasure-prevention tab.
- Set the **ON SCREEN** switch to the "ON" position.

❶ Press the **REC/PLAY SPEED** ▼ (or ▲) button to set the recording speed mode.

- *The recording speed mode is displayed on-screen and on the digital display.*

❷ Press the **REC** button.

- *The record indicator "○" light.*
- *Recording starts.*
- *When the end of the tape is reached, "OFF" will be displayed.*

NOTES:

- If in the (SET UP 2) menu, in the BUZZER section TAPE END is set to "Y", the buzzer will be heard as long as "OFF" is displayed on the digital display.
- To cancel the "OFF" display, press the **STOP**, **EJECT** or **PLAY** button or turn the **SHUTTLE** ring.
- If recording stops due to a problem with the tape or other reason, the unit will try once to resume recording. If the tape still does not advance, the VCR will go into stop mode.

❸ To stop recording, press the **STOP** button.

NOTES:

- A tape recording made on this VCR may not play back with the same degree of clarity on a time lapse from another manufacturer.
- If you press on the **REC** button and the loaded cassette has no erasure-prevention tab, the VCR will eject the cassette.

[Recording Speed Mode]

Recording speed mode (hour mode)	Maximum recording duration (hours)	Recording interval (second)	Audio recording	Tape motion
3	3	1/50	Possible	Continuous
12	15	5/50		
24	27	9/50		

Record Pause

Recording can be interrupted temporarily.

❶ Press the **STILL/PAUSE** button during recording.

- *The Pause/Still indicator "⏸" blinks.*

NOTES:

- The image appears on-screen but it is not recorded.
- If a recording pause continues for 5 minutes or more, the VCR will go into stop mode to avoid damaging the tape.

❷ To resume recording, press the **REC** button, or press the **STILL/PAUSE** button again.

NORMAL RECORDING

Concerning the Number of Times Tapes can be Rerecorded on

Depending on the recording speed mode, the tape must be replaced after a certain number of recording times.

Refer to the table below for the maximum number of times a tape can be recorded on.

Recording speed mode (hour mode)	Maximum number of recording times (with a standard grade tape)
3	100
12, 24	50

NOTES:

- The maximum number of recording times will vary depending on the location and kind of tape used. Verify the recording quality and replace the tape when the quality starts to deteriorate. The maximum number of recording times indicated above are based on test tapes (E-180) used by the company.
- If using longer tapes (i.e. E-240) the tape travel will not be as stable and that may cause problems.

Changes to the Recording Speed Mode During Recording

It is possible to permit or prevent changing the recording speed mode during recording.

- 1 Press the **MENU** button until the (SET UP 4) menu is displayed.

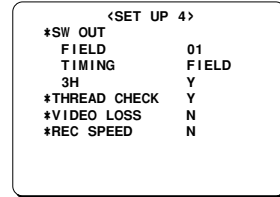

- 2 Turn the **JOG** dial, until the "REC SPEED" setting is flashing.
- 3 Turn the **SHUTTLE** ring, to set the desired mode.
 - Y. Recording speed mode can be changed
 - N. Recording speed mode can not be changed
- 4 Press the **SEARCH/AUDIO ON** button to save the setting.

Action to Take when the Video Signal Deteriorates

If there is no video signal during recording, fast forward, rewind modes, when in stop mode or when a tape is not loaded the menus are not displayed, "VIDEO LOSS" can be displayed on-screen and a signal (0 V) can be output at the **ALARM OUT** terminal. If in the (SET UP 2) menu, in the BUZZER section WARNING is set to "Y", the buzzer will be heard. To stop the buzzer, press the **STOP** button.

- 1 Press the **MENU** button until the (SET UP 4) menu is displayed.
- 2 Turn the **JOG** dial, until the "VIDEO LOSS" setting is flashing.
- 3 Turn the **SHUTTLE** ring, to set the desired mode.
 - N. The video loss warning is not active.
 - Y. The video loss warning is active.
- 4 Press the **SEARCH/AUDIO ON** button to save the setting.

NORMAL RECORDING

Recording Check

The image being recorded can be checked.

- ① During recording, press the **PLAY (REC CHECK)** button.
 - *The tape will be rewound and then played back. The VCR will then return to the previous recording mode.*

NOTE:

- During recording check operations, recording is suspended momentarily.

Clog Detection

This VCR is equipped with a clog detection function.

The recording quality is monitored automatically. When the heads are dirty and the recording quality deteriorates, the output at the **WARNING OUT** terminal becomes 0V (Low), the "○" indicator flashes on the digital display, and the buzzer sounds.

If in the (SET UP 3) menu, CLOG DETECT. is set to "N", the recording quality is not monitored.

NOTES:

- To cancel the "○" indicator display and reset the **WARNING OUT** terminal output, press the **STOP** button.
- Clog detection is not possible if recording in 3-hour mode.

AUTOREPEAT RECORDING

Autorepeat Recording

The same tape can be recorded over many times.

- Follow the **Before starting** steps, under “NORMAL RECORDING”.

- 1 Set the **REPEAT REC** switch to the “ON” position.
 - The *REPEAT* indicator will light.
- 2 Press the **MENU** button until the (SET UP 3) menu is displayed.
 - The “ALARM MODE” setting is flashing.

<SET UP 3>	
*ALARM MODE	Y1
*ALARM SPEED	3H
*ALARM DURATION	20S
*TAPE END MODE	R1
*TAPE END OUT	-3M
*CLOG DETECT.	Y
*RS-232C	19200

- 3 Turn the **JOG** dial, until the “TAPE END MODE” setting is flashing.
- 4 Turn the **SHUTTLE** ring to set to “R 1” or “R 2”. (See “Setting the Mode at the End of the Tape”)
- 5 Press the **SEARCH/AUDIO ON** button to save the setting.
- 6 Press the **REC/PLAY SPEED** ▼ (or ▲) button to set the recording speed mode.
- 7 Press the **REC** button.
 - Recording will start. When the tape end is reached, the VCR will rewind it to the beginning, and recording will resume.
 - When the end of the tape is reached, a buzzer will be heard (if in the (SETUP 2) menu, in the BUZZER section TAPE END is set to “Y”) and “OFF” will be displayed until the rewinding operation starts.

NOTES:

- If during autorepeat recording there is an alarm trigger, “AL” is displayed on the digital display and alarm recording will take place. (Please refer to page 18, “ALARM RECORDING”.)
- If the “TAPE END MODE” setting is R 1, the REPEAT indicator will go off if there is an alarm trigger. The recording will continue to the end of the tape then it will be rewound to the beginning and stop. “OFF” will be displayed on the digital display. To turn off the buzzer (if in the (SETUP 2) menu, in the BUZZER section TAPE END is set to “Y”) and the “OFF” display, press the **STOP**, **EJECT** or **PLAY** button, or turn the **SHUTTLE** ring.
- If “AL” is displayed on the digital display and the “TAPE END MODE” setting is R1, autorepeat recording is not possible.

Setting the Mode at the End of the Tape

In the (SET UP 3) menu, you can set the mode of the VCR mode when the tape reaches the end during recording.

- 1 Press the **MENU** button until the (SET UP 3) menu is displayed.

<SET UP 3>	
*ALARM MODE	Y1
*ALARM SPEED	3H
*ALARM DURATION	20S
*TAPE END MODE	REW
*TAPE END OUT	-3M
*CLOG DETECT.	Y
*RS-232C	19200

- 2 Turn the **JOG** dial, until the “TAPE END MODE” setting is flashing.
- 3 Turn the **SHUTTLE** ring, to set the desired mode.
 - Setting when the **REPEAT REC** switch is set to the “OFF” position.
 - REW Rewinds the tape to the beginning, then goes to stop mode
 - STOP Goes to stop mode
 - EJECT The cassette is ejected
 - Setting when the **REPEAT REC** switch is set to the “ON” position.
 - R1 Autorepeat recording mode is automatically canceled if there was an alarm trigger
 - R2 Autorepeat recording mode is active even if there was an alarm trigger
- 4 Press the **SEARCH/AUDIO ON** button to save the setting.

ALARM RECORDING

By connecting the **ALARM IN** terminal to a door switch, an interphone, etc., a recording can be done only when necessary.

Alarm Recording Setting

Alarm recording is performed when there is an input (trigger) at the **ALARM IN** terminal, "AL" is displayed on the digital display.

- Make all necessary connections.
- Follow the **Before starting** steps, under "NORMAL RECORDING".

- 1 Press the **MENU** button until the (SET UP 3) menu is displayed.

<SET UP 3>	
*ALARM MODE	Y1
*ALARM SPEED	3H
*ALARM DURATION	20S
*TAPE END MODE	REW
*TAPE END OUT	-3M
*CLOG DETECT.	Y
*RS-232C	19200

- 2 Turn the **SHUTTLE** ring to set the desired alarm mode.
 - Y1 Alarm recording is done when there is an alarm trigger.
 - Y2 Alarm recording is done only when there is an alarm trigger during programmed timer recording.
 - Y3 Alarm recording is done only if there is an alarm trigger and the VCR is not in programmed timer recording mode.
 - Y4 Alarm recording is done only when there is an alarm trigger during programmed timer recording duration. Timer recording is not possible.
 - N Alarm recording is not performed even if there is an alarm trigger.

- 3 Turn the **JOG** dial, until the "ALARM SPEED" setting is flashing.

- 4 Turn the **SHUTTLE** ring, to select the desired recording speed.

- 3H 3-hour mode recording
- 12H 12-hour mode recording
- 24H 24-hour mode recording
- NC Recording at the speed already set

- 5 Turn the **JOG** dial, until the "ALARM DURATION" setting is flashing.

- 6 Turn the **SHUTTLE** ring, to select the desired alarm recording duration (20S, 40S, 1M, 2M, 3M, 4M, 5M, or CC).

- 20S-5M. Recording only for the displayed duration
- CC Recording as long as the alarm signal is being input (minimum 5 seconds)

- 7 Press the **SEARCH/AUDIO ON** button to save the settings.

NOTES:

- During alarm recording all buttons are disabled.
- If "OFF" is displayed on the digital display, alarm recording is not possible in order to prevent the recorded tape to be recorded over. To cancel the "OFF" display, press the **STOP**, **EJECT** or **PLAY** button or turn the **SHUTTLE** ring.
- If an alarm trigger is received while alarm recording is in progress, recording duration for the second alarm will be calculated from that point. The alarm counter will register the alarm, but it will not be found during an alarm scan and alarm search.
- If there is a power failure during alarm recording, and the power is restored within the recording set duration, alarm recording will continue.
- If the alarm recording duration is short, the alarms may not be found during an alarm scan or an alarm search. If the alarms are going to be reviewed using alarm scan or alarm search, then in 3-hour mode, 20-second or more recording duration should be used.
- To do alarm recording during series recording, set "ALARM MODE" to "Y1" or "Y3". Alarm recording will be conducted only if the VCR is recording.

ALARM RECORDING

Alarm Recording Counter Display

- During alarm recording, “AL” will be flashing on the digital display.
- If the **ON SCREEN** switch is set to the “ON” position, the number of alarms will flash on the monitor screen.
- The maximum display number of alarm recordings is “999”, at the next alarm recording the counter will indicate “000”.
- When the (ALARM TIME) menu is displayed, press the **MENU RESET** button to reset the alarm counter to “000” (all the data of the (ALARM TIME) menu is reset).

Connections to the ALARM IN/OUT Terminals

- Alarm input signal
Connect a make-contact (no voltage) switch between the **ALARM IN** and **COM** terminals.
- Alarm output signal
Normally DC 5V are output between the **ALARM OUT** and the **COM** terminals. When an alarm input (trigger) is received and the unit is recording, the output falls to 0V. Once the alarm recording is over, the output returns to DC 5V.

Checking the Alarm Recordings Time

- 1 Press the **MENU** button until the (ALARM TIME) menu is displayed.
 - *The number of alarm recordings, and the 8 most recent alarm recording times are displayed.*

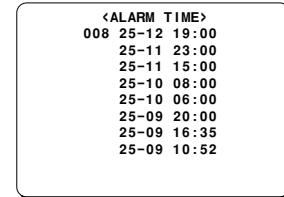

```
<ALARM TIME>
008 25-12 19:00
    25-11 23:00
    25-11 15:00
    25-10 08:00
    25-10 06:00
    25-09 20:00
    25-09 16:35
    25-09 10:52
```

NOTE:

- The data for the previous alarm recordings is erased.

- 2 Press the **SEARCH/AUDIO ON** button, the normal screen is displayed.

NOTE:

- If the **MENU RESET** button is pressed while the (ALARM TIME) menu is displayed, the displayed data is erased. “AL” will be erased from the digital display.

ALARM RECORDING

Alarm Search

To go to the beginning of a desired alarm recording.

- ❶ Press the **SEARCH/AUDIO ON** button during stop mode.
 - "AL SEARCH 01" will be displayed on screen.
- ❷ Press the **REC/PLAY SPEED** ▼ (or ▲) button to set the desired alarm number (1 to 99), then turn the **SHUTTLE** ring clockwise (or counterclockwise).
 - The desired alarm is searched and a still image of the beginning of the alarm recording will appear on-screen.

NOTE:

- The alarm number is relative to the actual tape position. (Please refer to the illustration below.)

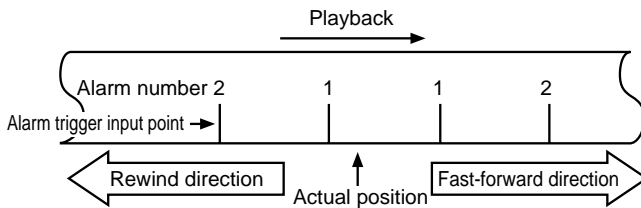

- ❸ Press the **PLAY** button.
 - Playback will start.

Alarm Scan

To look for an alarm recording by viewing the first 5 seconds of each alarm recording.

- ❶ Press the **SEARCH/AUDIO ON** button twice during stop mode.
 - "AL SCAN" will be displayed on screen.
- ❷ Turn the **SHUTTLE** ring clockwise (or counterclockwise).
 - The unit will advance (or rewind) the tape at high speed and playback the first 5 seconds of every alarm recording.
 - To cancel the alarm scan mode, press the **STOP** button.
- ❸ While the desired recording is being played back, press the **PLAY** button.
 - Playback will start, alarm scan mode is cancelled.

PROGRAMME TIMER RECORDING

There are two programme timer recording methods, daily recording or recording on certain days of the week.

Example 1: To record on every Saturday from 9:00 AM to 5:00 PM (17:00), in 24-hour mode (recording speed).

- Follow the **Before starting** steps, under "NORMAL RECORDING".

1 Press the **MENU** button until the (TIMER SET) menu is displayed.

- "SUN" (Sunday) will be flashing.

<TIMER SET>			
WEEK	START	STOP	SPD
SUN	--:--	--:--	--- N
MON	--:--	--:--	--- N
TUE	--:--	--:--	--- N
WED	--:--	--:--	--- N
THU	--:--	--:--	--- N
FRI	--:--	--:--	--- N
SAT	--:--	--:--	--- N
DLY	--:--	--:--	--- N
EXT	*****	*****	--- N

2 Turn the **JOG** dial, until "SAT" (Saturday) is flashing.

3 Turn the **JOG** dial clockwise.

- The recording start hour position starts flashing.

4 Turn the **SHUTTLE** ring to set the recording start hour (ex: 09), then turn the **JOG** dial clockwise.

- The recording start minutes position starts flashing.

5 Turn the **SHUTTLE** ring to set the recording start minutes (ex: 00), then turn the **JOG** dial clockwise.

- The recording stop hour position starts flashing.

6 Turn the **SHUTTLE** ring to set the recording stop hour (ex: 17), then turn the **JOG** dial clockwise.

- The recording stop minutes position starts flashing.

7 Turn the **SHUTTLE** ring to set the recording stop minutes (ex: 00), then turn the **JOG** dial clockwise.

- The "SPD" (recording speed) position will start flashing.

NOTE:

- If the set stop time is earlier than or the same time as the set start time, the VCR will consider the stop time to be the following day, and "T" will be displayed next to the recording stop time.
- 8 Turn the **SHUTTLE** ring to select the recording speed mode (ex: 24), then turn the **JOG** dial clockwise.
- "N" will start flashing.

9 Turn the **SHUTTLE** ring to select the desired program timer recording mode.

Y. recording will take place

N. recording will not take place

<TIMER SET>			
WEEK	START	STOP	SPD
SUN	--:--	--:--	--- N
MON	--:--	--:--	--- N
TUE	--:--	--:--	--- N
WED	--:--	--:--	--- N
THU	--:--	--:--	--- N
FRI	--:--	--:--	--- N
SAT	09:00	17:00	24 Y
DLY	--:--	--:--	--- N
EXT	*****	*****	--- N

- Repeat steps 2 to 9 to programme timer recordings for other days of the week.

10 Press the **SEARCH/AUDIO ON** button to save the settings.

11 Press the **TIMER** button.

- The timer recording indicator "□" will light on the digital display, the VCR is now in timer recording stand-by mode.

NOTES:

- To modify, cancel or stop timer recording, press the **TIMER** button to cancel the timer recording mode.
- To record everyday at the same time, at step 2 select the "DLY" line.

Setting up a programme timer recording of more than 24 hours

A programme timer recording of more than 24 hours can be set on the 7th (SAT) and 8th (DLY) lines.

1 Press the **MENU** button until the (TIMER SET) menu is displayed.

2 On the 7th line, set the desired recording starting day of the week and start time, then set "**" for the stop time.

- The rest of the settings, up to the next line start time, will change to "**".

3 On the 8th line, set the desired recording stop time and recording speed, then set "Y" for the recording programme timer recording mode.

4 Follow steps 10 and 11 above.

PROGRAMME TIMER RECORDING

Setting the Holidays

By setting the holidays, timer recording will be conducted on those days, as set for Sundays.

- 1 Press the **MENU** button until the (HOLIDAY SET) menu is displayed.

<HOLIDAY SET>	
1	11
2	12
3	13
4	14
5	15
6	16
7	17
8	18
9	19
10	20

- 2 Turn the **SHUTTLE** ring to set the day of the holiday, then turn the **JOG** dial clockwise.
- 3 Turn the **SHUTTLE** ring to set the month of the holiday.
- 4 Turn the **JOG** dial, until the next line to set starts flashing.
 - o Repeat steps 2 to 4 to set up to 20 holidays.
- 5 Press the **SEARCH/AUDIO ON** button to save the settings.

NOTES:

- If setting holidays, be sure that a timer recording is set for Sunday. If not, this function will not operate.
- If a timer recording for Sundays is entered, the holidays timer recording will not function if the programme timer recording mode is set to "N".
- To erase a setting, follow the same procedure as above, but at step 2 and 3, enter "--" instead of a setting.

Changing a Programme Timer Recording

- 1 Press the **MENU** button until the (TIMER SET) menu is displayed.
- 2 Turn the **JOG** dial, until the setting to correct is flashing.
- 3 Turn the **SHUTTLE** ring, to correct the setting.
- 4 Press the **SEARCH/AUDIO ON** button to save the settings.
- 5 Press the **TIMER** button.

To Cancel a Programme Timer Recording

- 1 Press the **MENU** button until the (TIMER SET) menu is displayed.
- 2 Turn the **JOG** dial, until the "Y" corresponding to the timer recording to cancel is flashing.
- 3 Turn the **SHUTTLE** ring, to select "N".
- 4 Press the **SEARCH/AUDIO ON** button to save the settings.
- 5 Press the **TIMER** button.

To Cancel all Programme Timer Recordings

- 1 Press the **MENU** button until the (TIMER SET) menu is displayed.
- 2 Press the **MENU RESET** button.
 - o All programmed timer recordings are erased.
- 3 Press the **SEARCH/AUDIO ON** button, the normal screen is displayed.

PROGRAMME TIMER RECORDING

NOTES:

- During timer recording or timer recording stand-by, all the buttons on the VCR, except the **TIMER** button and the buttons to set/cancel the security lock (see page 28), are disabled.
- If the power fails, the recording will be interrupted. When the power is restored, the recording will resume if the stop time has not yet been reached, and "P" will be displayed on the digital display. The VCR internal battery is completely recharged after the VCR has been connected to a live outlet for 48 hours, and it will maintain all the VCR settings memory for up to 30 days.
- Set the timer recordings so that the recording times do not overlap. If they do, the one with the earliest recording start time will have priority. (See chart below.)

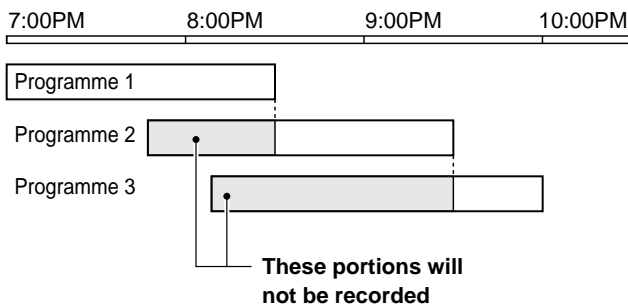

- To set two or more timer recordings for a same day of the week, turn the **JOG** dial, until the day of the week for the second recording is flashing, then turn the **SHUTTLE** ring, to set the desired day of the week.
- If no timer recording is set or a cassette without erasure-prevention tab is loaded, when the **TIMER** button is pressed the timer recording indicator "□" will start flashing and a buzzer will be heard.
- If "OFF" is displayed on the digital display, timer recording is not possible in order to prevent the recorded tape to be recorded over.

RECORDING USING AN EXTERNAL TIMER INPUT

Recording can be controlled by an external start/stop signal input at the **EXT TIMER IN** terminal.

Example 2: To record using the signal input at the **EXT TIMER IN** terminal, in 24-hour mode.

- Follow the **Before starting** steps, under “NORMAL RECORDING”.

NOTE:

- External timer input recording can only be set on the 9th line (EXT) of the (TIMER SET) menu.
- 1 Press the **MENU** button until the (TIMER SET) menu is displayed.
 - 2 Turn the **JOG** dial, until “EXT” (External) setting is flashing.
 - The “SPD” (recording speed) position will start flashing.
 - 3 Turn the **SHUTTLE** ring to select the recording speed mode (ex: 24), then turn the **JOG** dial clockwise.
 - “N” will start flashing.
 - 4 Turn the **SHUTTLE** ring to select “Y”.

<TIMER SET>			
WEEK	START	STOP	SPD
SUN	--:--	--:--	--- N
MON	--:--	--:--	--- N
TUE	--:--	--:--	--- N
WED	--:--	--:--	--- N
THU	--:--	--:--	--- N
FRI	--:--	--:--	--- N
SAT	--:--	--:--	--- N
DLY	--:--	--:--	--- N
EXT	*****	*****	24 Y

- 5 Follow steps 10 and 11 under “PROGRAMME TIMER RECORDING on page 21”.
 - When an external signal is input, “E” will light on the digital display and recording will take place.

NOTES:

- Other timer recordings using the standard procedure can also be programmed.
- The external input signal must be input at the **EXT TIMER IN** terminal.

NORMAL PLAYBACK

Normal Playback

- 1 Turn on the power to the VCR and TV monitor.
- 2 Load the video cassette tape.
- 3 Press the **REC/PLAY SPEED** ▼ (or ▲) button to select the playback speed mode.
 - *The selected playback speed mode is displayed on the digital display.*

NOTE:

- A slow motion effect or accelerated playback effect can be achieved by using a slower or faster playback speed than the speed used for recording.
- 4 Press the **PLAY** button.
 - *Playback starts.*
 - *If necessary, adjust the tracking to eliminate the noise from the picture.*
 - *If the image is unstable (rolling vertically), adjust the vertical lock control to correct.*
 - 5 To stop playback, press the **STOP** button.
 - *To advance or rewind the tape, turn the **SHUTTLE** ring clockwise or counterclockwise.*

NOTES:

- If a tape recorded in SP mode on a standard VCR is loaded, playback will be done in 3-hour mode.
- A tape recorded on a time lapse VCR produced by another manufacturer may not play back with the same degree of clarity on this unit.

Tracking Control

If there is noise in the image during playback,

- 1 While looking at the playback picture, press and hold the **TRACKING/V. STILL+** button to minimize the noise.
- 2 If it cannot be minimized, press the **TRACKING/V. STILL-** button.

Vertical Lock Control

During still image mode,

- 1 Press and hold the **TRACKING/V. STILL+** button to reduce the vertical rolling of the image.
- 2 If it cannot be corrected, press the **TRACKING/V. STILL-** button.

Sharpness Control

Turn the **SHARPNESS** control clockwise or counterclockwise for the desired sharpness of the image.

Audio Playback

- Audio playback is only possible in 3-hour, 12-hour and 24-hour modes.
- The playback speed has to be the same as the recording speed, for normal playback of the audio.
- For a tape recorded in 12-hour and 24-hour recording modes, to playback the audio, press the **SEARCH/AUDIO ON** button after pressing the **PLAY** button. "A" will be displayed to the left of the playback speed on the digital display.

NOTE:

- Noise will appear in the image when audio playback is used in 12- or 24-hour modes.

SPECIAL PLAYBACK

Picture Search (Forward and Reverse)

- 1 Turn the **SHUTTLE** ring clockwise (or counterclockwise), during normal playback. See “SHUTTLE Ring Operation”.
 - *The image can be seen while the tape is advanced (or rewound) at high speed.*
- 2 To return to normal playback, release the **SHUTTLE** ring.

NOTES:

- During picture search, noise (horizontal bars) will appear in the picture.
- The sound is muted.

Still Image

- 1 Press the **STILL/PAUSE** button, during normal playback.
 - *A still image can be viewed.*
- 2 To return to normal playback, press the **PLAY** button.

NOTES:

- If still mode continues for 5 minutes or more, the VCR will go into stop mode to avoid damaging the tape.
- If the image is unstable (rolling vertically), adjust the vertical lock control to correct.

Frame Advance

- 1 Turn the **JOG** dial clockwise (or counterclockwise), during still image mode.
 - *The still image is advanced (or rewound) of one image (field).*
 - *Turn the dial faster to increase the speed of the frame advance.*
- 2 To return to normal playback, press the **PLAY** button.

NOTES:

- During reverse frame advance, noise will appear in the picture.
- If frame advance mode continues for 5 minutes or more, the VCR will go into stop mode to avoid damaging the tape.

Reverse Playback

- 1 Turn the **SHUTTLE** ring counterclockwise and hold it, during normal playback. See “SHUTTLE Ring Operation”.
 - *Reverse playback will start.*
- 2 To return to normal playback, release the **SHUTTLE** ring.

NOTES:

- During reverse playback, noise will appear in the picture.
- If operated from normal playback mode, reverse playback is only possible during 3-hour playback speed mode.
- The sound is muted.

Slow motion (Forward and Reverse)

- 1 Turn the **SHUTTLE** ring clockwise (or counterclockwise) and hold it, during still image mode. See “SHUTTLE Ring Operation”.
 - *Forward (or reverse) slow motion playback will start.*
- 2 To return to normal playback, press the **PLAY** button.

NOTES:

- If slow motion mode continues for 5 minutes or more, the VCR will go into stop mode to avoid damaging the tape.
- The sound is muted.

SPECIAL PLAYBACK

Day/Time Search

- Press the **SEARCH/AUDIO ON** button three times during stop mode.
 - "T/D SEARCH 01 00:00" will be displayed on screen.

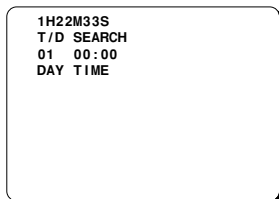

- Press the **REC/PLAY SPEED** ▼ (or ▲) button to set the desired day, then turn the **JOG** dial clockwise.
- Press the **REC/PLAY SPEED** ▼ (or ▲) button to set the desired hour, then turn the **JOG** dial clockwise.
- Press the **REC/PLAY SPEED** ▼ (or ▲) button to set the desired minutes.

NOTES:

- The setting can be made in 10 minutes increments only.
 - For recordings made on other VCRs, the exact time may not be found even if the minutes are entered. For tapes recorded on older models of VCRs produced by this company (the ones without a minutes setting for the day/time search function), make sure to set the minutes to "00".
- Turn the **SHUTTLE** ring clockwise (or counterclockwise).
 - The desired day/time is searched and a still image of the recording will appear on-screen.
 - Press the **PLAY** button.
 - Playback will start.

NOTES:

- If during a search the end of the tape is reached, the tape will rewind and stop. If the beginning of the tape is reached, it will stop.
- The alarm and day/time data are recorded on the tape in a similar format. If they overlap, the alarm data will have the priority. Therefore, when searching for a day/time when an alarm recording was done, the day/time search will not stop at the desired location. In such a case, use alarm scan to find the desired recording location.
- The day/time search function may not operate correctly if searching for a timer recording time or if the clock on the recording VCR has been adjusted using the **CLOCK ADJUSTMENT** function.
- Depending on the recording conditions, the function may not operate properly.

SHUTTLE Ring Operation

From normal playback, still image, stop mode, etc., turn the clockwise or counterclockwise to select a mode as indicated below.

- Turn the **SHUTTLE** ring in either direction where the desired mode is selected.

 : Operation will not return to the original mode when the **SHUTTLE** ring is released.

Reverse direction		Original mode	Forward direction	
Rewind		*1		Fast forward
Reverse picture search (Locked)		*2		Forward picture search (Locked)
Reverse picture search	Reverse playback	Normal playback	Normal playback	Forward picture search
Reverse picture search	Reverse playback	Reverse Slow motion	Still image	Slow motion
		Normal playback	Normal playback	Forward picture search

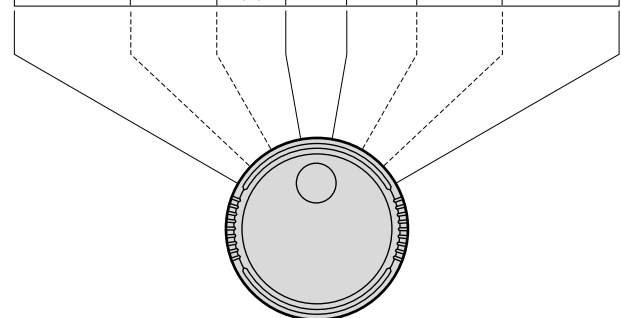

*1: Stop mode, Forward picture search or Reverse picture search.

*2: Fast forward or Rewind

NOTES:

- If operated from still image mode and playback mode, operation will return to the original mode when the **SHUTTLE** ring is released.
- If operated from normal playback mode, reverse playback is only possible during 3-hour playback speed mode.
- The sound is muted.

TAPE COUNTER

Using the counter, it is easy to find a desired recording.

- ❶ Press the **COUNTER RESET** button, at the beginning of the desired recording.
 - *The counter will be reset to "0_H 00_M 00_S".*
- ❷ Press the **COUNTER MEMORY** button.
 - *"M" is displayed on the digital display.*
 - *To cancel the counter memory function, press the **COUNTER MEMORY** button a second time.*
- ❸ After recording or playback, turn the **SHUTTLE** ring counterclockwise from stop mode.
 - *The tape is rewound to the counter "0_H 00_M 00_S" reading.*
 - *If you rewind the tape past the "0_H 00_M 00_S" position, turn the **SHUTTLE** ring clockwise.*

NOTES:

- There is no tape counter indication for the blank portions of the tape.
- In the 3-hour recording speed mode only, the tape counter indicates real hours, minutes and seconds.
- In the other recording speed modes, the tape counter indication is a ratio of the 3-hour mode base indication. (In 12-hour recording mode, each "second" of the tape counter actually represents approximately $15/3 = 5$ real seconds.)
- There may be a slight discrepancy between the position shown on the tape counter and the actual tape position.
- When rewinding the tape past the "0_H 00_M 00_S" position, a minus (-) sign will be displayed.

SETTING THE SECURITY LOCK

The security lock function is designed to prevent accidental stopping of recording if the **STOP** button is pressed inadvertently.

- ❶ While holding the **SHIFT** → button, press the **REC/PLAY SPEED** ▲ button.
 - *"L" is displayed on the digital display.*

To cancel the security lock, while holding the **SHIFT** → button, press the **REC/PLAY SPEED** ▼ button, "L" will be erased from the digital display.

NOTES:

- While the security lock is engaged all commands, except the one to cancel the security lock, are disabled.
- The security lock cannot be engaged while a menu is displayed.

SETTING THE BUZZER

A buzzer can be set to sound during alarm recording, if during recording the tape reaches the end, if buttons are pressed or if there is a mechanical failure that causes the tape to stop or be ejected, etc.

- 1 Press the **MENU** button until the (SET UP 2) menu is displayed.

<SET UP 2>	
*DISPLAY	
DATE	Y
TIME	Y
ALARM COUNT	Y
SPEED	Y
*BUZZER	
ALARM IN	Y
TAPE END	Y
KEY IN	N
WARNING	Y

- 2 Turn the **JOG** dial, until the desired item for which the buzzer function will be set is flashing.
- 3 Turn the **SHUTTLE** ring to set "Y" for the functions described below.

ALARM IN . . . The buzzer will be heard during alarm recording.

TAPE END . . . The buzzer will be heard when the end of the tape is reached during recording. To stop the buzzer, press the **STOP**, **EJECT** or **PLAY** button, or turn the **SHUTTLE** ring.

KEY IN The buzzer will be heard when one of the VCR buttons is pressed or when the **JOG** dial or the **SHUTTLE** ring is turned.

WARNING . . . The buzzer will be heard if the heads are dirty and recording quality deteriorate, or if the tape stops or is ejected due to a problem with the internal mechanism. To stop the buzzer, press the **STOP** button.

- 4 Press the **SEARCH/AUDIO ON** button to save the setting.

NOTES:

- If "N" is set, the buzzer will not be heard.
- During timer recording mode, security lock engaged mode and alarm recording mode, the buzzer will not be heard when a button related to one of these modes is pressed, even if "Y" is set for the "KEY IN" item.

SETTING THE RS-232C OR RS-485 DATA TRANSFER SPEED

The VCR can be controlled by a computer connected to the RS-232C connector. It can also be controlled through a special controller connected to the RS-485 connector.

You must specify which connector (RS-232C or RS-485) is used. (Refer to "Data Transfer Speed Setup.")

DIP Switches Setup

The **DIP** switches need to be set when a computer, special controller, etc. connected to the RS-232C or RS-485 connectors is used to control the VCR. Make sure to turn the VCR power off before setting the **DIP** switches.

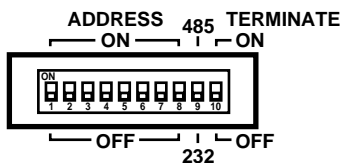

SW No.

1-7: To setup the VCR address (only when using the RS-485 connector).

- Switch 1 is the least significant bit (LSB) and switch 7 the most significant bit (MSB) (Down: 0, Up: 1)

Example:

- If the address is 1, set switch 1 to the ON side (up)
- If the address is 10, set switches 2 and 4 to the ON side (up)
- If the address is 127, set all the switches to the ON side (up)

8: Available (Not used)

9: To select the connector used. [232] side (down) for RS-232C, [485] side (up) for RS-485.

10: To setup the termination (only when using the RS-485 connector).

OFF side (down): Not terminated

ON side (up): Terminated

NOTE:

- Refer to the RS-232C and RS-485 command section or to the special controller and/or to the computer instruction manual.

Data Transfer Speed Setup

- 1 Press the **MENU** button until the (SET UP 3) menu is displayed.

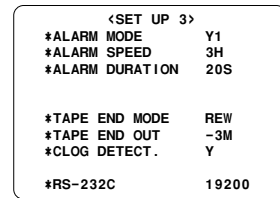

- 2 Turn the **JOG** dial, until the "RS-232C" or "RS-485" setting is flashing.

NOTE:

- The display will depend on the DIP switch 9 setting. When down "RS-232C" is displayed and when up "RS-485" is displayed.

- 3 Turn the **SHUTTLE** ring to set the desired transfer speed.

- 4 Press the **SEARCH/AUDIO ON** button to save the setting.

RS232C 9-pin connector layout

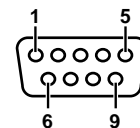

Pin number	Signal	Operation	Signal direction
2	RXD	Receive data	VCR ← Computer
3	TXD	Send data	VCR → Computer
7	RTS	Request to send	VCR → Computer
5	GND	Signal ground	

The signal transmission is compatible with RS-232C specifications.

SETTING THE RS-232C OR RS-485 DATA TRANSFER SPEED

RS485 RJ-11 connector layout

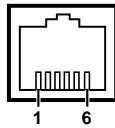

NOTE: Do not connect to phone line.

Pin number	Connector A signal	Connector B signal
1	Not used	Not used
2	Not used	Not used
3	A	B
4	B	A
5	Not used	Not used
6	Not used	Not used

A: Non-inverting driver output/receiver input

B: Inverting driver output/receiver input

RS-485 Connection

This VCR can use the straight type or crossed type connecting cables.

If using a straight type cable, connect it from the "A" to the "A" or from the "B" to the "B" RS-485 connector.

If using a crossed type cable, connect it from the "A" to the "B" or from the "B" to the "A" RS-485 connector.

Types of cables

Straight type: A cable with pin connection number correspondence (i.e. pin 1 to pin 1, pin 2 to pin 2, etc.).

Crossed type: A cable without pin connection number correspondence.

CHECKING POWER FAILURE, FAILURE DUE TO CONDENSATION AND USAGE DURATION

- Press the **MENU** button until the (POWER FAILURE), (DEW) and (USED TIME) menu is displayed.

(POWER FAILURE) . . . The number of power failures, and the date and time of the most recent power failure and recovery are displayed.

(DEW) The number of failures due to condensation, and the date and time of the most recent failure and recovery are displayed.

(USED TIME) The video heads usage duration and the power on duration are displayed.

Example

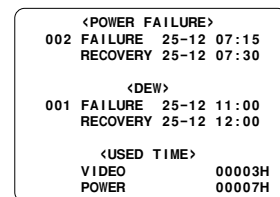

- Press the **SEARCH/AUDIO ON** button, the normal screen is displayed.

NOTE:

- If the **MENU RESET** button is pressed while the (POWER FAILURE) and (DEW) menu is displayed, the data is erased. The (USED TIME) data cannot be reset. "P" will be erased from the digital display.

OUTPUT TERMINALS

SW OUT Terminal

When recording, a pulse signal is output at the **SW OUT** terminal.

This terminal is usually connected to the switch input (SW IN) of devices like a camera switcher unit, or a quad compressor.

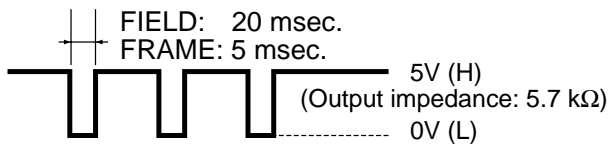

SW OUT Terminal Output Setting

- Press the **MENU** button until the (SET UP 4) menu is displayed.
 - The *FIELD* (or *FRAME*) setting is flashing.

<SET UP 4>	
*SW OUT	
FIELD	01
TIMING	FIELD
3H	Y
*THREAD CHECK	Y
*VIDEO LOSS	N
*REC SPEED	N

NOTE:

- If "TIMING" is set to FRAME (see step 4), "FRAME" will be indicated instead of "FIELD".
- Turn the **SHUTTLE** ring, to set the desired pulse signal interval.

Available settings are:

FIELD 01, 02, 03, 04, 05, 10, 30 or 60 field

FRAME 01, 02, 03, 04, 05, 10, 30 or 60 frame
 - Turn the **JOG** dial clockwise until the "TIMING" setting is flashing.
 - Turn the **SHUTTLE** ring, to set "FIELD" or "FRAME".

FIELD 1 pulse is output after each set number of fields.

FRAME 1 pulse is output after each set number of frames.
 - Turn the **JOG** dial clockwise until the "3H" setting is flashing.
 - Turn the **SHUTTLE** ring, to set the desired "3H" mode.

Y When recording in 3-hour mode, a pulse signal is output.

N When recording in 3-hour mode, a pulse signal is not output.
 - Press the **SEARCH/AUDIO ON** button to save the settings.

TAPE END OUT Terminal

- During recording, when the end of the tape is reached or when the tape counter reading indicates 2 hours 57 minutes or more, the output becomes 0V (Low).
- To reset the output, press the **STOP** or **EJECT** button.
- During autorepeat recording, when the end of the tape is reached, the output becomes 0V (Low) for about 2 seconds only.

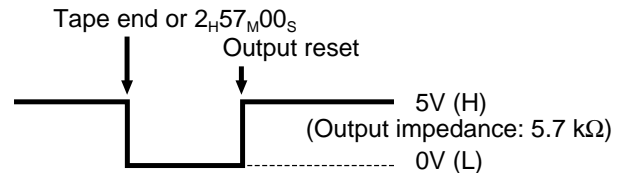

TAPE END OUT Terminal Output Setting

- Press the **MENU** button until the (SET UP 3) menu is displayed.

<SET UP 3>	
*ALARM MODE	Y1
*ALARM SPEED	3H
*ALARM DURATION	20S
*TAPE END MODE	REW
*TAPE END OUT	-3M
*CLOG DETECT.	Y
*RS-232C	19200

- Turn the **JOG** dial, until the "TAPE END OUT" setting is flashing.
- Turn the **SHUTTLE** ring, to select the desired output mode.

-3M The output becomes 0 V (Low) when the tape counter reaches "2H57M00s" and/or when the tape reaches the end.

END The output becomes 0 V (Low) when the tape reaches the end.
- Press the **SEARCH/AUDIO ON** button to save the setting.

OUTPUT TERMINALS

REMOTE Jack

You can use a VA-RMN01 Remote Control Unit (sold separately) to control remotely the VCR.

NOTE:

- The functions not available on the VCR will not operate.

Remote control of the VCR is possible by connecting a remote controller with a circuit such as indicated below, to the **REMOTE** jack.

NOTES:

- Use a 3.5 mm mini-jack type plug.
- The connection should be done using a shielded cable no more than 5 meters long.
- The functions not available on the VCR will not operate.

Remote control circuit

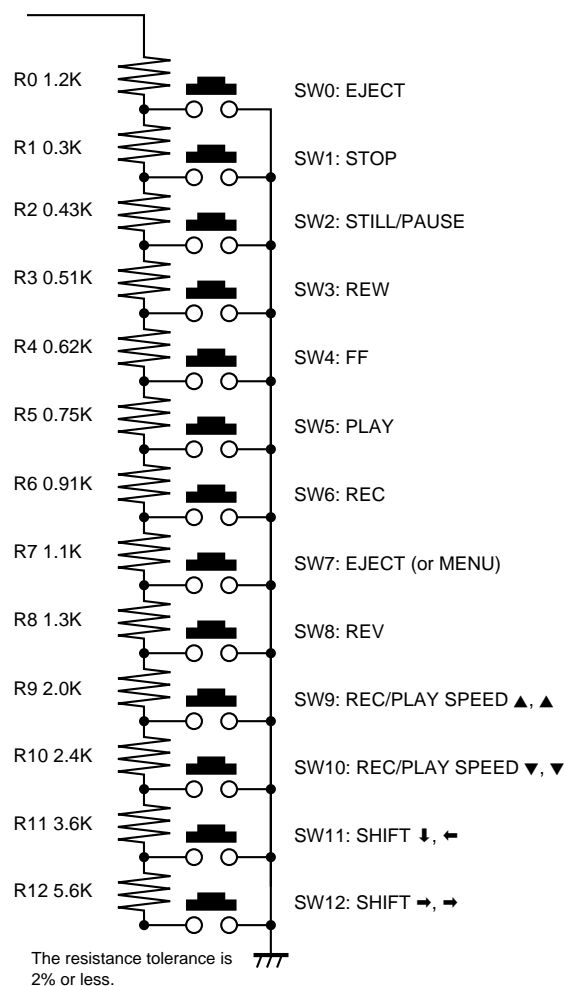

Remote control setting

The remote control switch 7 can be set to either eject the tape or access the menus.

- 1 Press the **MENU** button until the (SET UP 1) menu is displayed.

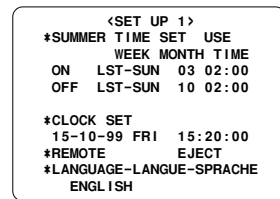

- 2 Turn the **JOG** dial, until the "REMOTE" setting is flashing.

- 3 Turn the **SHUTTLE** ring, to select the desired switch mode.

EJECT Switch 7 will eject the tape.

MENU. Switch 7 will display the menu.

- 4 Press the **SEARCH/AUDIO ON** button to save the setting.

WARNING OUT Terminal

- If the tape stops or other problem, the output becomes 0V (Low).
- To reset the output, press the **STOP** or **ALL RESET** button or unplug the power cord then plug it back in.

Tape movement stop

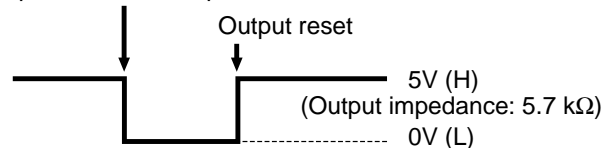

NOTE:

- If the output is 0V (Low) due to the clog detect function, it can be reset by simply pressing the **STOP** button.

COM Terminal

- Common GND (ground) terminal when connecting other terminals to external devices.

MAINTENANCE

Daily Inspection

The following daily inspections are recommended in order to assure long-term and trouble-free operation of the unit.

The daily inspections are particularly important if using autorepeat recording.

Inspection Procedure

- ❶ Turn on the power to the VCR, camera, TV monitor and other connected devices.
- ❷ Check that the image received on the TV monitor is correct.
- ❸ Check that the on-screen display of the date and time is correct.
- ❹ To check the recording condition of the previous day, rewind the recorded tape a few seconds.
- ❺ Press the **PLAY** button and check that the playback image is correct.
- ❻ Check that the recorded date and time are correct.

NOTES:

- If the security lock is engaged, it has to be released before proceeding to the inspection.
- If any problem is discovered during the inspection, turn off the VCR, unplug the power cord then consult your dealer.

Periodic Inspection

Periodic inspection and maintenance should be referred to your dealer.

If there is noise in the playback picture, and it cannot be corrected using the tracking control, it may indicate that the video heads need cleaning.

The video heads should be inspected every 1,000 hours of use to determine if they need to be replaced.

The video heads usage can be checked using the (USED TIME) menu.

Cabinet Cleaning

Clean the outside of the cabinet with a clean, soft cloth, moistened with lukewarm water and wrung dry.

DO NOT USE SOLVENTS OR OTHER TYPES OF CLEANERS. THESE CHEMICALS CAN CRACK OR DISCOLOR THE CABINET.

About the Backup Battery

The date and time settings are maintained for up to 30 days by a rechargeable lithium battery that is fully charged after the VCR has been connected to a power source for 48 hours or more.

Depending on the battery usage it may become necessary to change it. For replacement and disposal of the old battery, please contact your dealer.

After the battery has been replaced, press the **ALL RESET** button, then enter all the time, date, etc. settings as required.

MAINTENANCE

Maintaining and Checking The Mechanism

To maintain the VCR functions and features working properly, and to avoid damages or dirt on the tape, it is recommended to follow the maintenance points and periodicity indicated below.

For detailed information, please contact your dealer.

Maintenance Table

○ : Cleaning ◎ : Confirmation △ : Lubrication □ : Change

	PARTS	2000H	4000H	6000H	8000H	NOTES
Tape Path System	ASSY, BRAKE BAND	◎	□	◎	□	
	ASSY, LEVER BT (tape guide)	○	○	○	○	
	FULL ERASE HEAD	○	○	○	□	
	ASSY, ROLLER CLEANER	◎	□	◎	□	
	ASSY, GUIDE ROLLER	○	○	○	○	
	ASSY, MOUNTING INCLNE S	○	○	○	□	
	ASSY, MOUNTING INCLNE T	○	○	○	□	
	ACE HEAD	○	○	○	□	
	ASSY, LEVER PINCH ROLLER	○	□	○	□	
	MOUNTING, LIFT PINCH				□	
	CAM, LIFT PINCH				□	
	GEAR, CAM PINCH				□	
	ASSY, EARTH CYL		□		□	
	COMPL, CYLINDER	○	○(□)	○	○(□)	
ASSY, CYLINDER UPPER	○(□)	○(□)	○(□)	○(□)		
Reel Drive System	ASSY, REEL SUPPLY	○△	○△	○△	○△	
	ASSY, REEL TAKEUP	○△	○△	○△	○△	
	GEAR, REEL S	△	△	△	△	
	GEAR, REEL T	△	△	△	△	
	PULLEY, REEL	△	△	△	△	
	SPECIAL, WASHER 2.4 X 6 X 0.25		◎		◎	
	COMPL, MOUNTING CLUTCH	△	□	△	□	
	BELT, REEL	◎	□		□	
	MOTOR, CAPSTAN	○	◎(□)	◎(□)	□	
	ASSY, GEAR FRICTION	△	△□	△	△□	
Brake	ASSY, BRAKE S	◎	◎	◎	◎	
	ASSY, BRAKE T	◎	◎	◎	◎	
	ASSY, BRAKE CAPSTAN	◎	◎	◎	◎	
	ASSY, BRAKE SOFT T		◎		□	
Loading Drive System	ASSY, LOADING MOTOR		◎		□	
	DAMPER				□	
	COMPL, GEAR WORM		◎		□	
	CAM, MAIN				□	
	SPECIAL WASHER 3.6 X 0.5		◎		□	
	GEAR, WHEEL 1				□	
	GEAR, WHEEL 2		◎		□	
	MODE SWITCH		◎		□	
	SLIDE, CRECENT		◎		□	
	GEAR, LOAD S		◎		□	
	GEAR, RACK FRONT		◎		□	
GEAR, RACK START		◎		□		
GEAR, PINON		◎		□		
Performance Check	BACK TENSION TORQUE	◎	◎	◎	◎	PB BACK TENSION TORQUE 25~50g·cm
	FWD, REW TORQUE	◎	◎	◎	◎	FWD, REW TORQUE ≥ 600g·cm
	PLAY TORQUE	◎	◎	◎	◎	PLAY 55 ~ 110g·cm
	REV TORQUE	◎	◎	◎	◎	REV 100 ~ 210g·cm

NOTE:

1. This table shows the maintenance for up to 8000 hours. After this, repeat from the start of the table.
2. For places with symbols such as ◎ (□) and ○ (□), carry out checking and cleaning, and replace if necessary.
3. This periodic maintenance check table changes considerably according to the using conditions and environment.
4. Refer to (USED TIME) menu for the length of time the unit has been used.
5. As life may be shortened if foreign particles and dusts remain accumulated on the tape guides and rotating and contacting portions, clean if dirty.
6. Dusts and other foreign particles on the tape guides may also shorten the tape life and lower picture quality, therefore clean thoroughly.

TROUBLESHOOTING GUIDE

If the unit does not operate normally when you follow the instructions indicated in the manual, please refer to the table below.

SYMPTOM	POSSIBLE CAUSE	CORRECTIVE ACTION
No power	The power cord is not connected	Connect the power cord
No image displayed on the monitor TV	The connections are not correct	Check that all connections are correct
	The power to the camera and/or monitor TV is not turned on	Turn all connected devices power on
The buttons do not respond	A cassette tape is not loaded	Load a cassette and turn the power on
	All functions are suspended due to condensation	Wait for the "ddd" indicator to go off
	Alarm recording	Wait for the alarm recording to end
	The security lock is engaged	Cancel the security lock
Recording is not possible (the tape is ejected)	The loaded cassette has no erasure-prevention tab	Load a cassette tape with erasure-prevention tab or cover the tab hole with adhesive tape
Autorepeat recording is not possible	"AL" is displayed on the digital display	Display (ALARM TIME) menu, then press the MENU RESET button to turn off the "AL" indicator
Timer recording is not possible	The date and time are not set correctly	Set the date and time correctly
	The unit is not set to timer recording stand-by mode	Press the TIMER button to display "□" on the digital display
	"N" is selected for the timer recordings	Be sure to select "Y" for the programmed timer recordings
Alarm recording is not possible	"OFF" is displayed on the digital display	Press the EJECT, STOP or PLAY button or turn the SHUTTLE ring to turn the indicator off
Noise in the playback picture	The video heads need cleaning	Clean the video heads
The date and time are not recorded	The ON SCREEN switch is set to the "OFF" position	Set the ON SCREEN switch to the "ON" position
The cassette tape cannot be ejected	Problem with the system	Unplug the power cord then plug it back in
The cassette is ejected a few seconds after it has been inserted	The tape is not threaded correctly	Try inserting the cassette one more time or using a new cassette. If it is ejected again, please consult your dealer.

After a Power Failure

If after a power failure the recording speed is reset to 3-hour mode, it is due to insufficient backup battery charge. This is not a malfunction.

System Down

If the unit does not function at all, try the following.

- ❶ Unplug the power cord then plug it back in.
- ❷ Reset the memory. (Press the **ALL RESET** button. Under normal conditions, do not touch the **ALL RESET** button.)
- ❸ If the problem is not corrected after performing steps ❶ and ❷ a few times, consult your dealer.

SPECIFICATIONS

General Specifications

Video heads system	Dual-azimuth 4-head rotating helical scanning system: Dual azimuth 2-head for record and standard playback Dual azimuth 4-head for forward picture search, reverse picture search and still mode
Audio recording	In 3-, 12- and 24-hour modes
Tape speed	23.39 mm /sec (3-hour mode)
Specified video cassette tape	VHS 1/2 inch video cassette tape
Recording/playback time	3, 12 and 24 hours (when using E-180 tape)
Fast forward/rewind time	approximately 2 minutes 45 seconds (when using E-180 tape)
Television system	PAL colour TV system
RS-232C/RS-485 data transfer speed	19200, 9600, 4800, 2400 baud

Video

Recording method	Luminance signal: FM recording Chrominance signal: Down-converted direct recording
Video input	1 V(p-p), BNC, 75 Ω , unbalanced
Video output	1 V(p-p), BNC, 75 Ω , unbalanced
Horizontal resolution	Black & white mode 350 line or more Colour mode 250 line or more

Audio

Input	-8 dBs, RCA pin jack, 27 k Ω , unbalanced
Output	-8 dBs, RCA pin jack, 600 Ω , unbalanced
Microphone input	-60 dBs, 3.5 mm mini jack, 10 k Ω , unbalanced

Connectors

Alarm input	Low level active (0V 100msec or more)
Alarm output	DC 5 V (± 0.5)/5.7 k Ω , Low at alarm
Switch output	DC 5 V (± 0.5)/5.7 k Ω , Low at switching
Tape end output	DC 5 V (± 0.5)/5.7 k Ω , Low at tape end
Warning output	DC 5 V (± 0.5)/5.7 k Ω , Low at warning
Ext timer input	Low level active (0V 100msec or more)
Common	0 V (GND)
Remote control input	3.5 mm mini jack

Other Specifications

Operating temperature range	5°C to 40°C
Operating humidity range	80% or less
Power requirements	220-240 V AC, 50 Hz
Power consumption	14 W
Dimensions	420 (W) x 99.5 (H) x 295.5 (D) mm
Weight	approximately 4.4 kg

NOTE: The specifications and external appearance of this unit are subject to change without notice.



SANYO Electric Co., Ltd.

1AC6P1P1901-BA
RR4Q/EX2
(1000KP-SY01)

Issue No. 4

Copyright SANYO, 2000 All rights reserved.

Printed in Japan